

WOLFSWINKEL RESIDENCE

Project Portfolio



Project ID 14353

Helping you create Architectural Style for your home



WOLFSWINKEL PROJECT PORTFOLIO



WOLFSWINKEL PROJECT PORTFOLIO

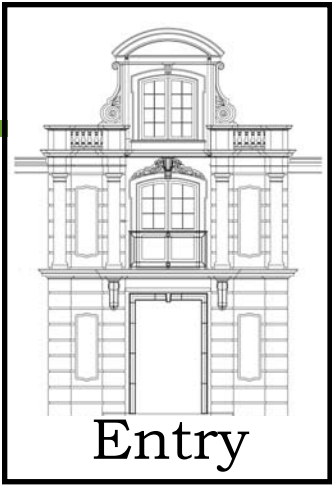

Entry

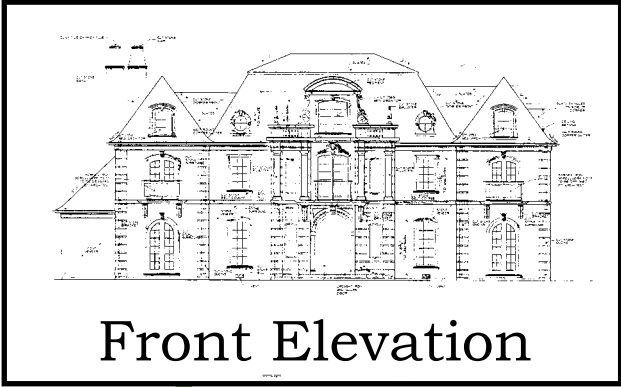

Front Elevation

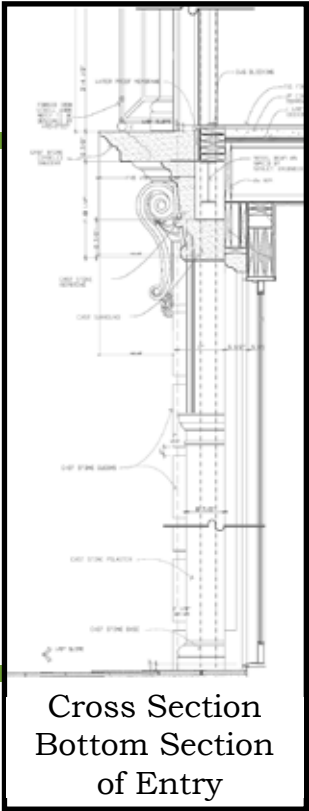

Cross Section
Bottom Section
of Entry

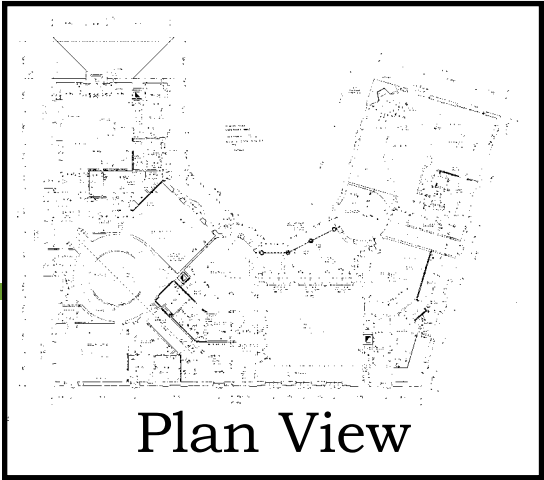

Plan View

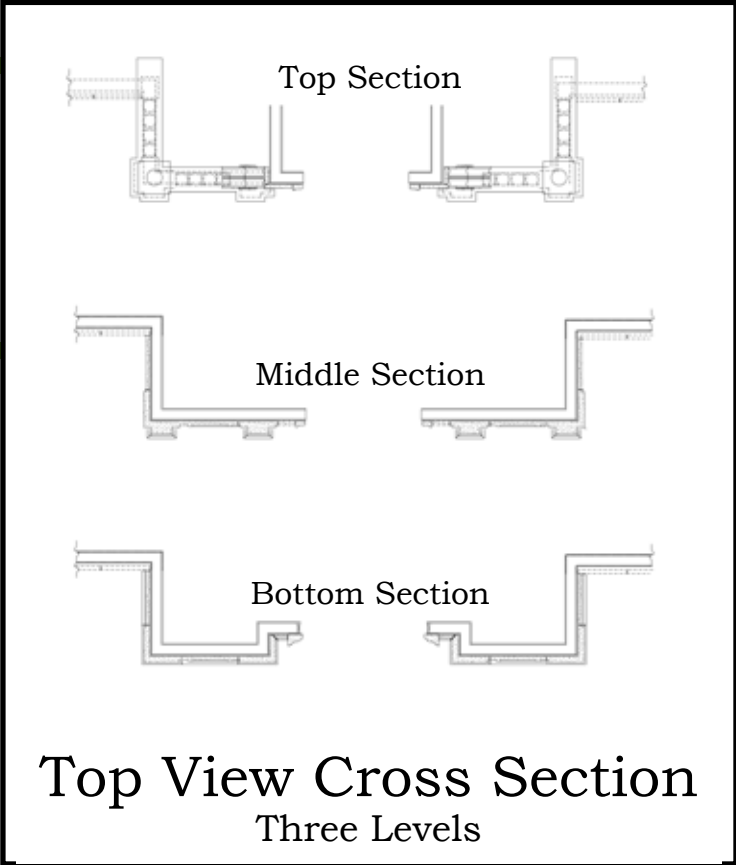

Top Section

Middle Section

Bottom Section

Top View Cross Section
Three Levels



Side View Elevation

WOLFSWINKEL RESIDENCE

Project Portfolio Contents



A

Surround
Top Level



B

Surround
Second Level



C

Entry
Bottom Level



Breaking Down The Project

Showing how the pieces fit together to make the style

WOLFSWINKEL RESIDENCE
Proj ID 14353

A

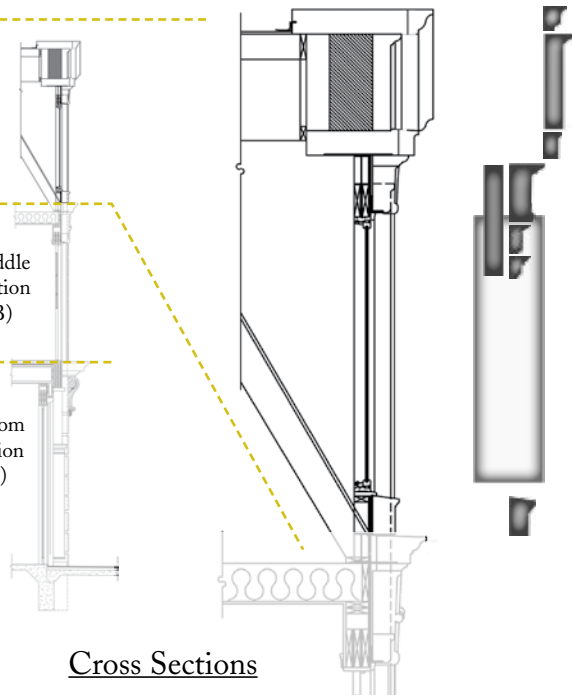
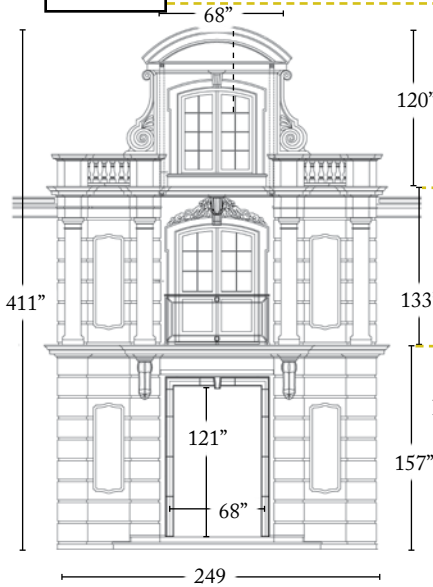

Cross Sections

- Ogee Profile (Crown)
- Custom Profile (Pediment)
- Custom Profile (Upper Banding)
- Custom Scroll (Keystone)
- Custom Profile (Window Surround) Top & Ears
- Custom Profile (Window Surround) Sides
- Flatface Panel (Wall Panel)
- Custom Scroll (Accent)
- Custom Profile (Window Sill)

Three Tiered Entry
Top Level



Breaking Down The Project

Showing how the pieces fit together to make the style

WOLFSWINKEL RESIDENCE
Proj ID 14353

B

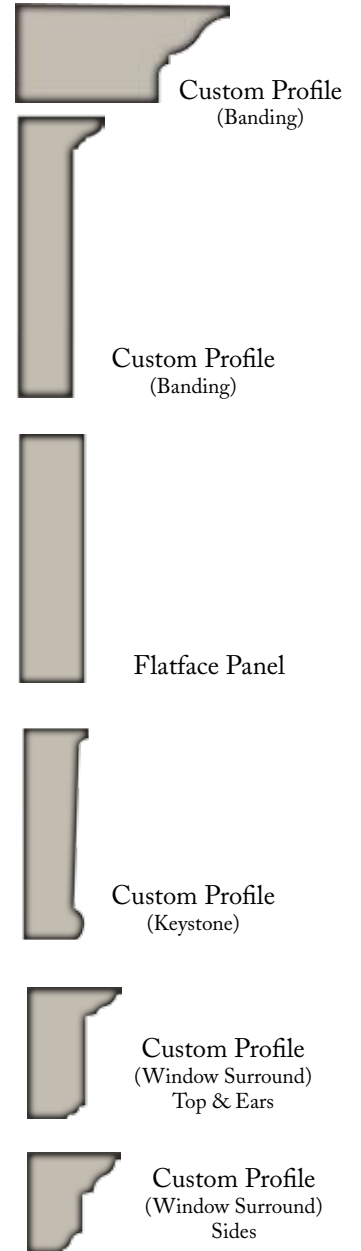
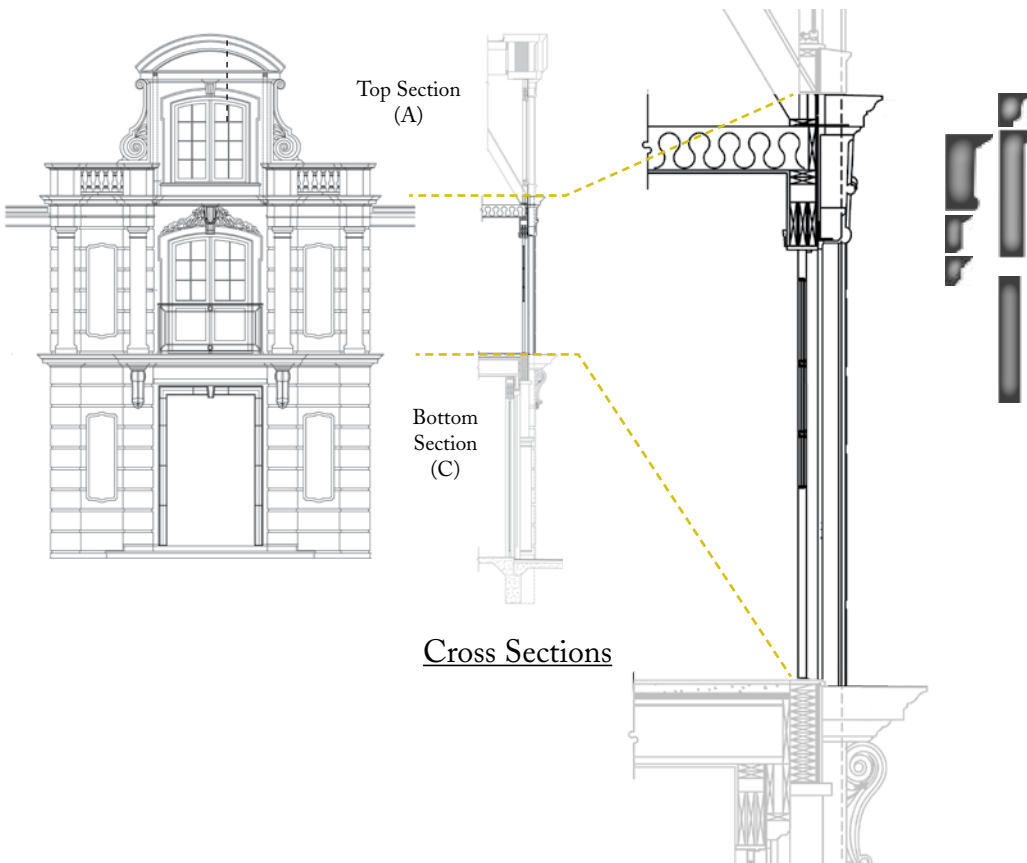

Three Tiered Entry
Second Level

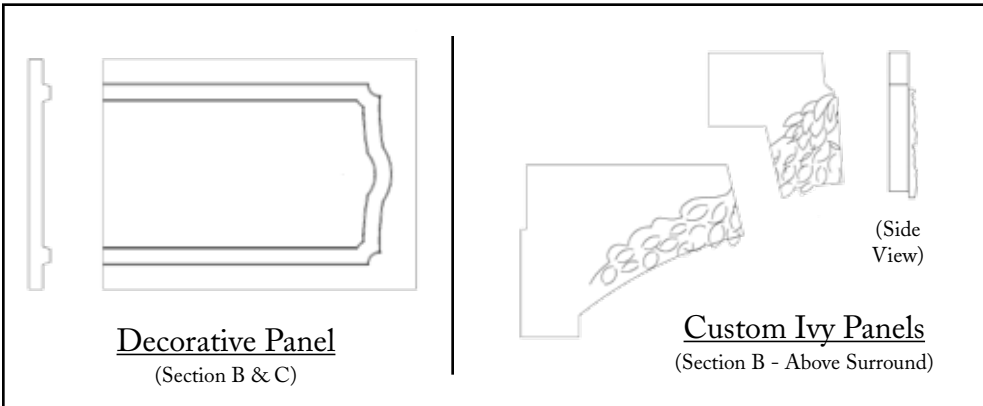

Breaking Down The Project

Showing how the pieces fit together to make the style

WOLFSWINKEL RESIDENCE
Proj ID 14353

C

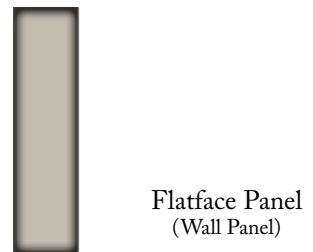
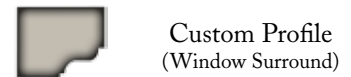
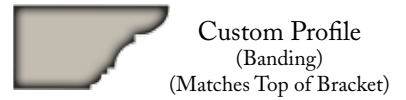
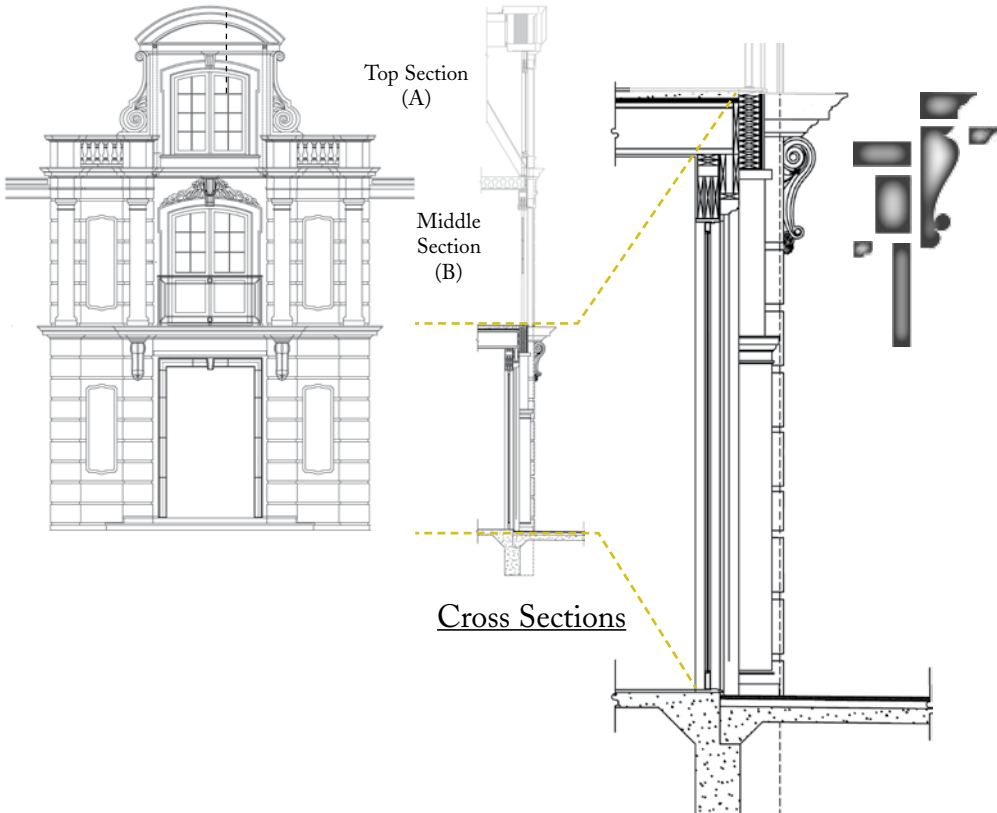

Three Tiered Entry
Bottom Level

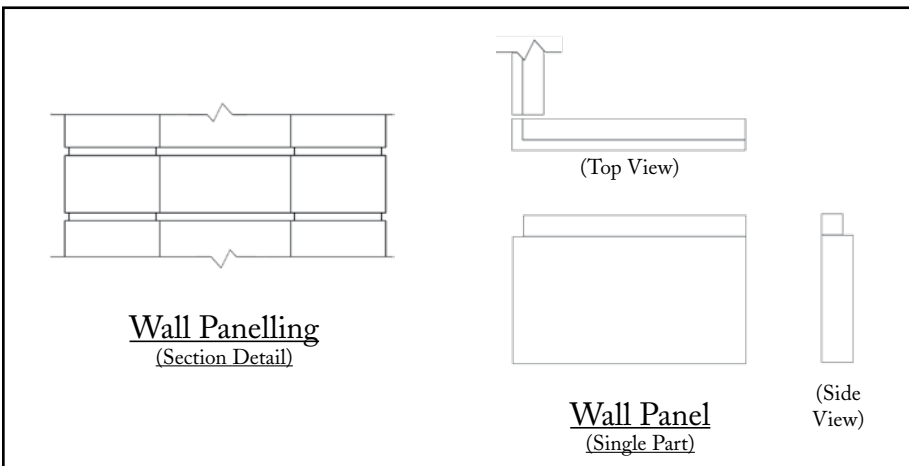

WOLFSWINKEL RESIDENCE
Proj ID 14353

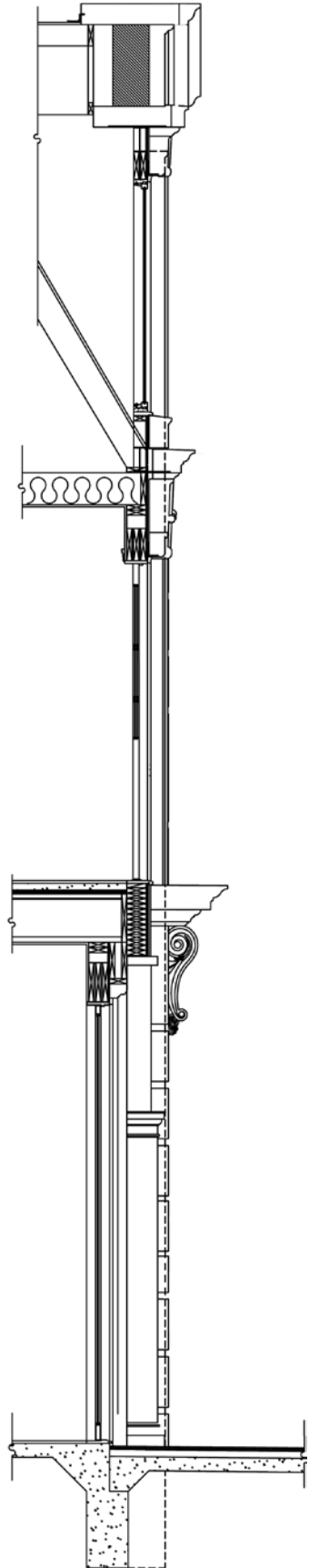
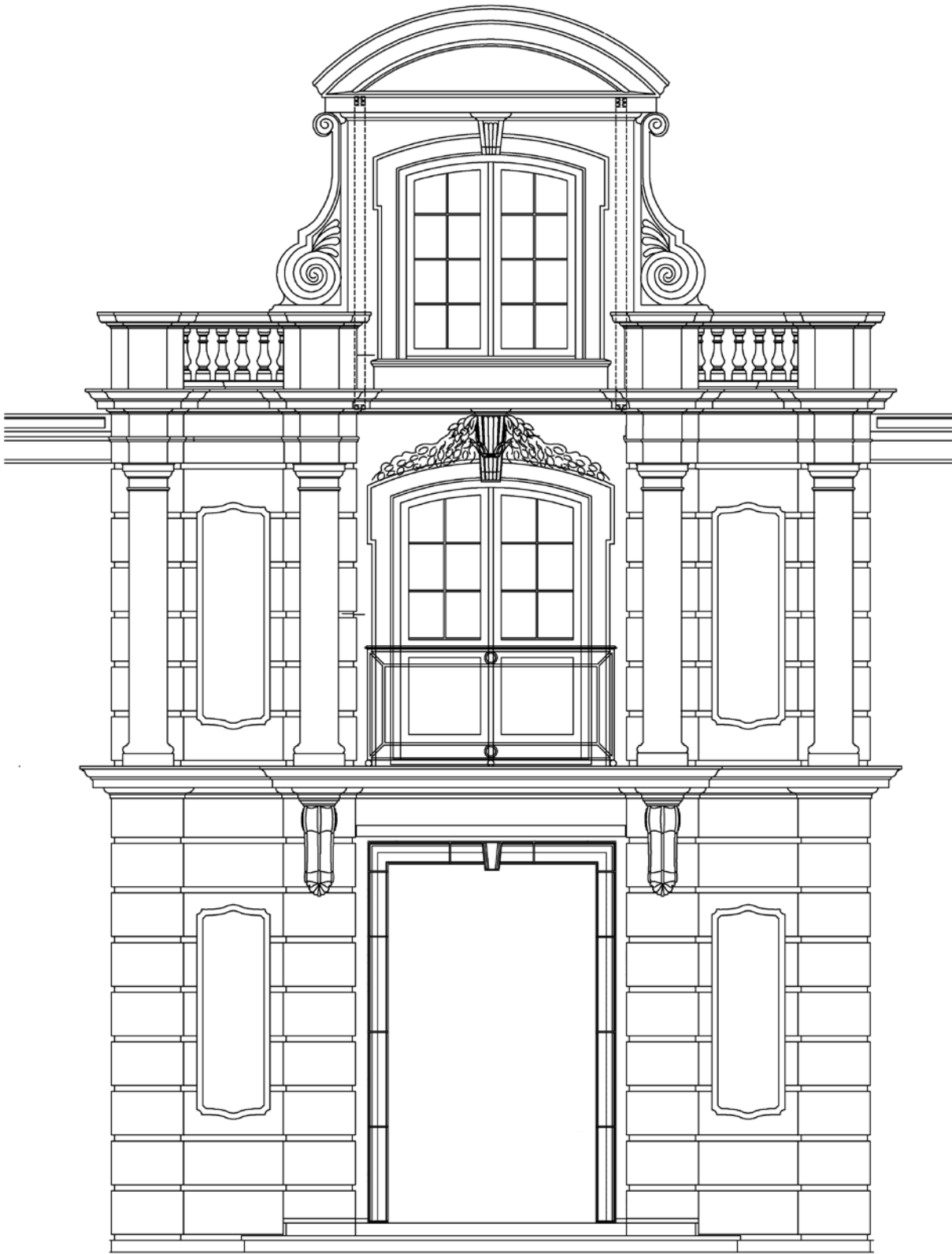

Front Facade
Complete Drawing & Cross Section